

Alctron 爱克创

K7

USB 录音麦克风

K7 USB studio microphone

用户手册

Owner's Manual



目录

English

1. GENERAL INTRODUCTION.....	2
2. THE INTRODUCTION OF EACH BUTTON.....	2
3. INSTALLTION.....	2
4. PRELIMINARY SET UP WITH WIN10.....	3
5. PRELIMINARY SET UP WITH MAC.....	4
6. RECODING SETTING.....	5
7. SPECIFICATION.....	5

中文

1. 产品介绍.....	6
2. 各个按钮的功能介绍.....	6
3. 安装.....	6
4. WIN10的初步设置.....	7
5. MAC的初步设置.....	8
6. 录音软件设置.....	9
7. 产品参数.....	9

GENERAL INTRODUCTION

K7 is a USB mic which features a premium 24bit/96khz sampling rate chips. Its cardioids condenser polar pattern capsule delivers dramatic, studio-quality sound directly to your PC, Mac, iPhone and iPad and other similar devices. The headphone volume control, mic level and mute control position in left and right side. New design shock mount with removable, collapsible function ensures convenient and easy to store. Practical, rich function and concise design ensure K7 suitable for diversity applications.

THE INTRODUCTION OF EACH BUTTON

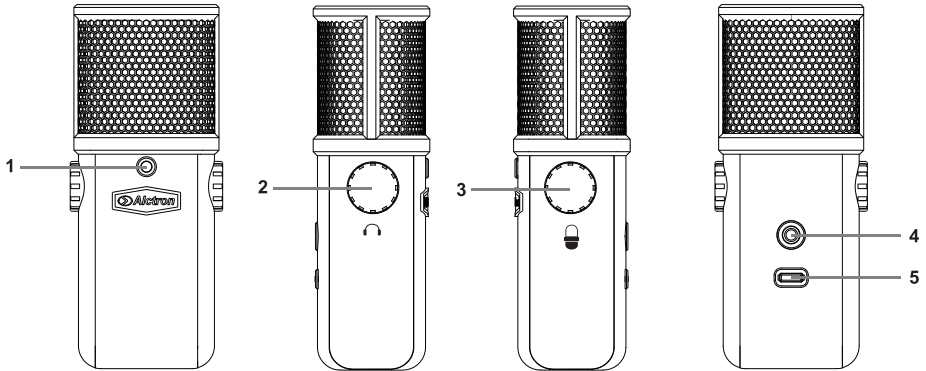

- 1.LED indicator, when there has USB power in, the blue LED will lit.
- 2.Headphone volume control, handle the headphone level.
- 3.Mic level control and recording mute knob. Switch the knob to control mic level and press the knob to mute sound.
- 4.Standard 3.5mm stereo headphone connector.
- 5.USB connector, connects to USB devices.

INSTALLTION

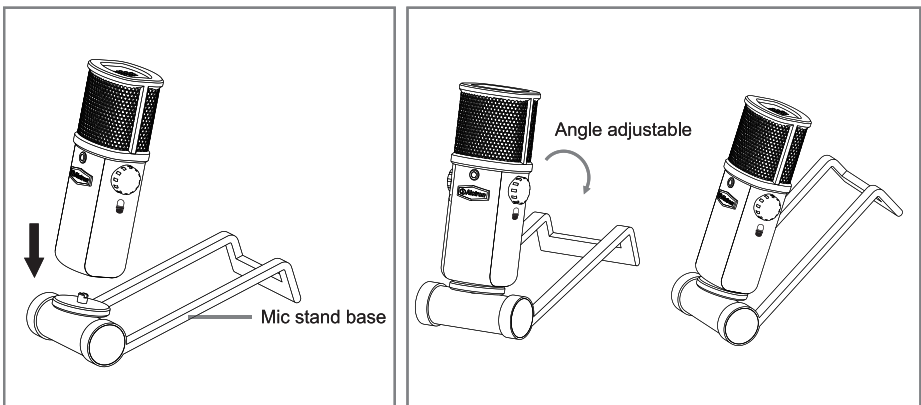

Switch the mic into mic stand base.

PRELIMINARY SET UP WITH WIN10

1. Plug the free end of the USB cable into the USB port on your computer. The microphone's blue LED light will illuminate, indicating the mic is receiving power. Your computer will automatically recognize the USB device and install a driver.

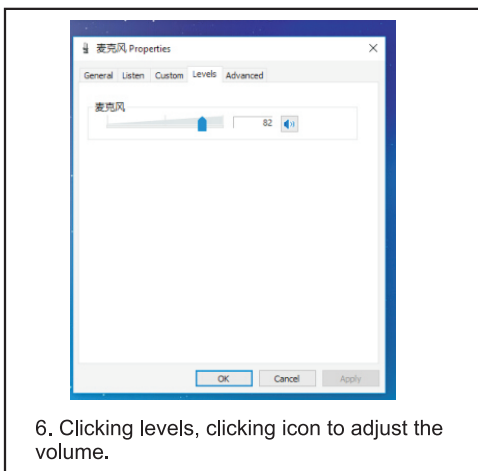
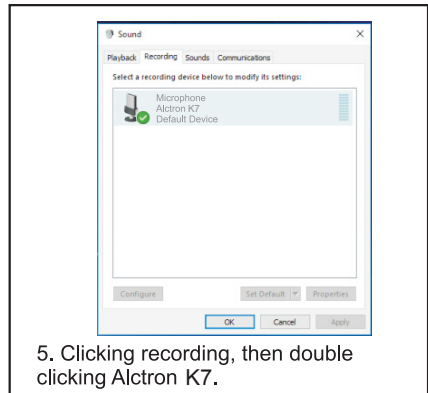
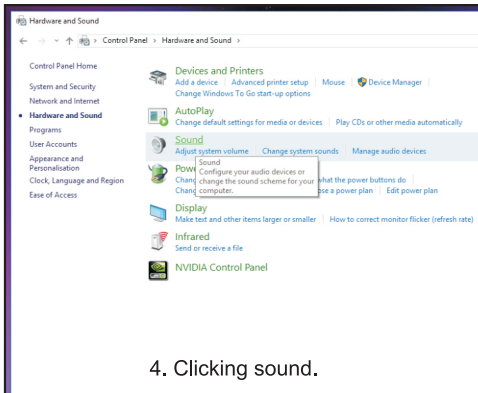
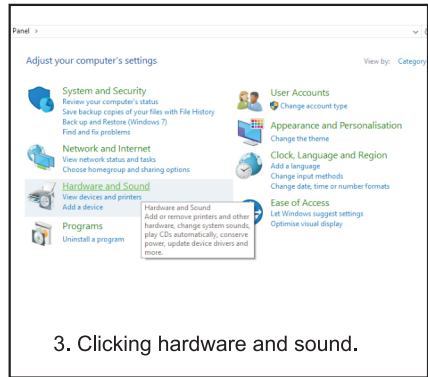
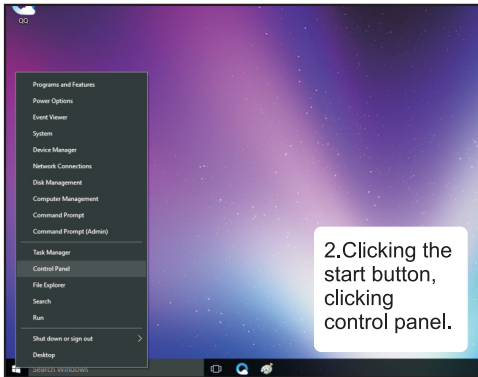

PRELIMINARY SET UP WITH MAC

1. Plug the free end of the provided USB cable into the USB port on your computer. The microphone's blue LED will illuminate, indicating the microphone is receiving power. Your computer will automatically recognize the USB device and install a driver.

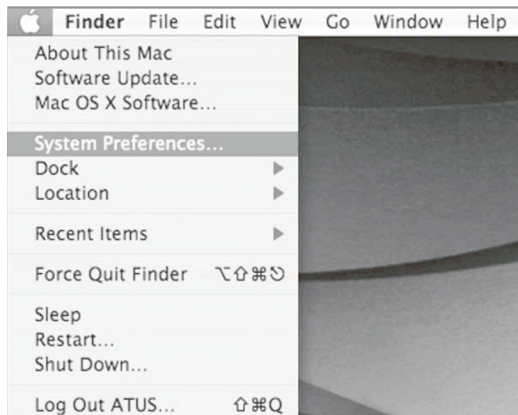

2. To select the Alcron K7-USB as your audio input, first, open your System Preferences.

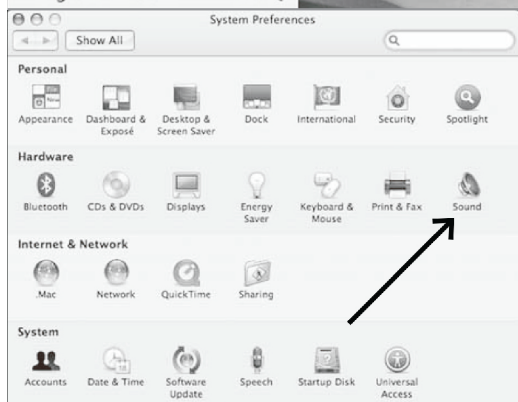

3. Next, click Sound to display the Sound preference pane.

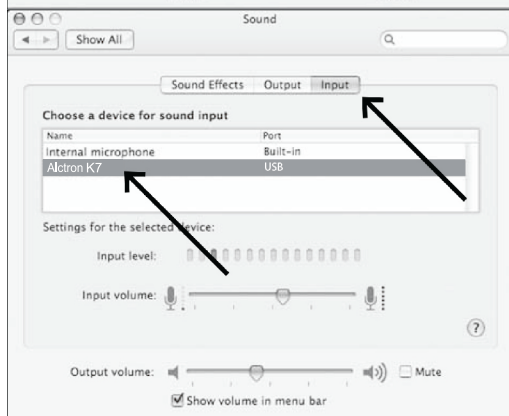

4. Click the Input tab and select the Alcron K7-USB as the device for sound input.

5. Your preferences are now set to use the Alcron K7-USB on your Mac with recording program of your choice.

RECODING SETTING

Taking the audacity recording software as an example, other similar software's setting method is the same:

1. After download, click audacity, Choice "edit"-specification setting.

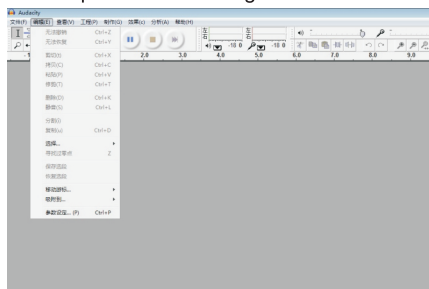

2. Pop up below screen, click the option as shows, you can choice stereo or mono.

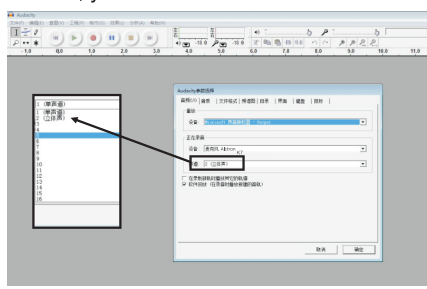

3. Click red icon, begin to recording.

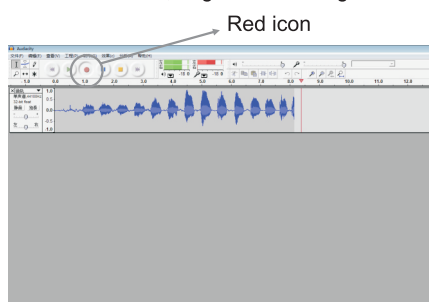

4. When starting recording, sound resource should aim to the side which printed "Alctron"



SPECIFICATION

- * Capsule: 16mm electrets capsule
- * Polar pattern: cardioid
- * Frequency response: 20hz-20khz
- * Sensitivity: -38dB
- * Max SPL: 110dB
- * Mic adjustable gain: 0-20dB
- * Sampling rate: 24bits/96k
- * Output connection: USB
- * Net weight: 420g
- * Mic size: 127x56mm

Copyright © Ningbo Alctron Electronics Technology CO.,LTD. All rights reserved. Specifications and appearance subject to change without notice.

Ningbo Alctron Electronics Technology CO.,LTD.
 No.76 SanCheng Road, XiuFeng Industrial Area,GaoQiao Town, NingBo, China.
 Tel:+0086 574 87150672
 Fax:+86 574 87157176
 E-mail:info@alctron-audio.com
 www.alctron-audio.com

产品介绍

K7是一款带有24比特/96khz采样率芯片的USB话筒。其心型指向性的电容音头可将原始清晰的音质传送至电脑，手机，平板等电子产品。话筒左侧设有耳机音量控制旋钮，右侧设有一键静音和话筒增益调节二合一旋钮。防震架可拆卸折叠的设计更便于话筒的使用与存放。丰富实用的功能和简洁高效的设计保证K7适用更多场景。

各个按钮的功能介绍

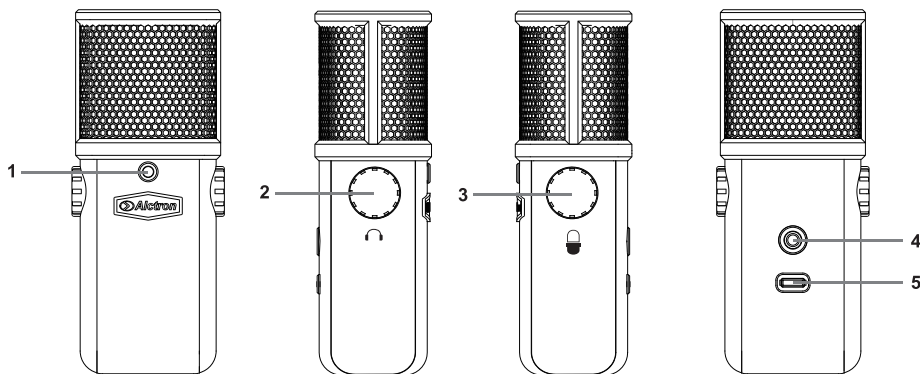

- 1.LED指示灯，如果连接USB，蓝色指示灯亮起
- 2.耳机音量控制旋钮，控制耳机音量的大小。
- 3.话筒音量控制以及录音静音旋钮。旋转此旋钮来调节话筒音量大小，按下此开关即为录音静音。
- 4.标准3.5mm立体声耳机接口。
- 5.USB接口，连接USB设备。

安装

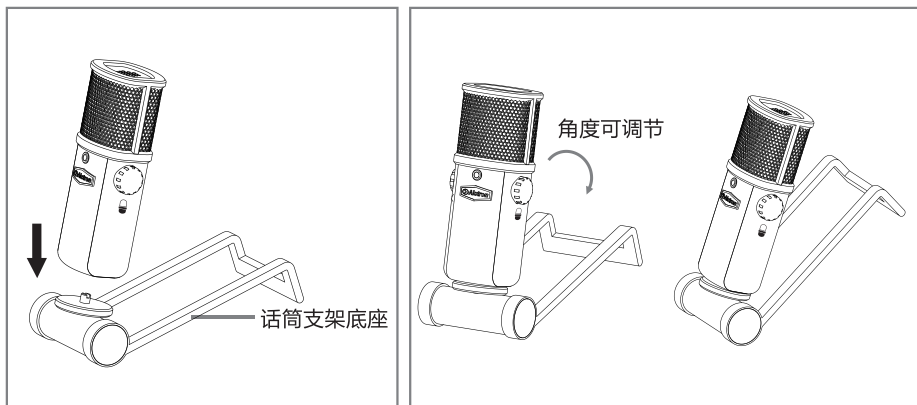

将话筒旋入话筒支架底座。

WIN10的初步设置

1.把USB 连线的另一端插入计算机上的USB 端口，话筒的蓝色LED 将会亮起，表示话筒已接通供电。您的计算机会自动识别USB 设备并安装驱动程序。



MAC的初步设置

1. 把USB连线的另一端插入计算机上的USB端口，话筒的蓝光LED将会亮起，表示话筒已接通供电。您的计算机会自动识别USB设备并安装驱动程序。

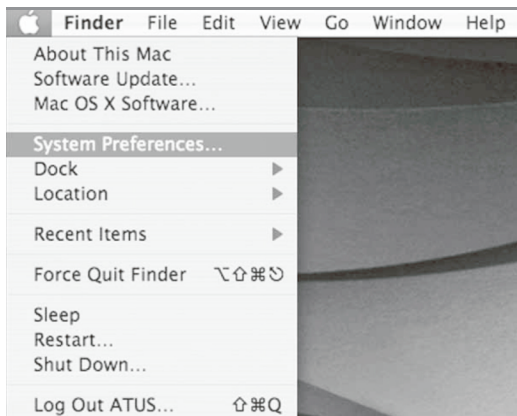

2. 选择“Alctron K7-USB”，作为音频输入，打开“System Preferences”。

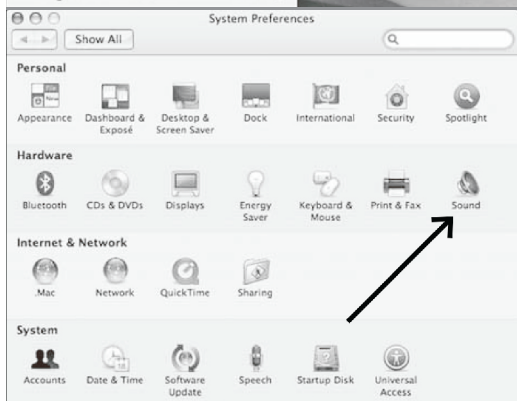

3. 点击“Sound”。

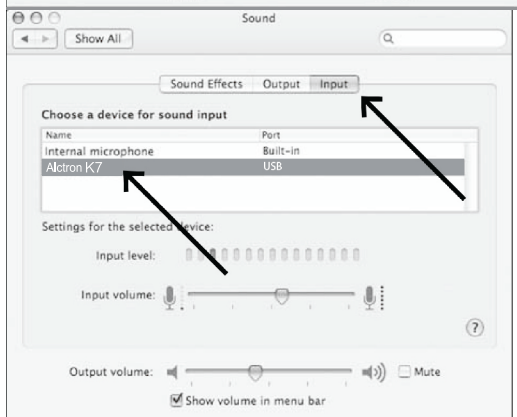

4. 点击“Input”并且选择“Alctron K7-USB”作为声音输入设备。

5. 接下来您就可以用录音软件进行录音了。

录音软件设置

以Audacity录音软件为例,其它类似软件设置方法一样:

1. 下载好软件后, 点击进入软件页面, 选择编辑-参数设定

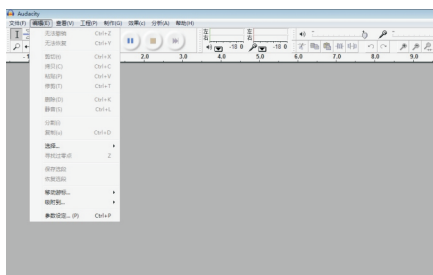

2. 会出现以下窗口, 选择跟画面一样的选项, 声道可以选择立体声或者单声道。

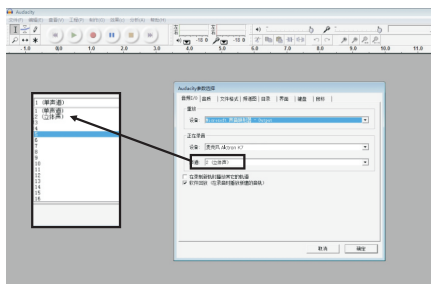

3. 点击红色图标, 开始录音。

红色图标

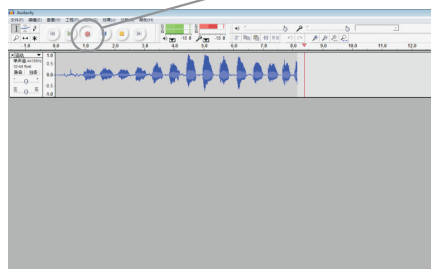

4. 当您开始录音的时候, 音源要对准印有 "Alctron" 字样的那面。



产品参数

- * 音头: 16mm驻极体音头
- * 指向性: 心型
- * 频响: 20hz~20khz
- * 灵敏度: -38dB
- * 最大声压级: 110dB
- * 话筒可调增益: 0-20dB
- * 采样率: 24bits/96k
- * 输出接口: USB接口
- * 产品净重: 420g
- * 话筒尺寸: 127x56mm

版权所有©宁波奥创电子科技有限公司,所有权保留。必要的技术数据和外观更改恕不另行通知。

宁波奥创电子科技有限公司

地址：浙江省宁波市海曙区秀丰工业区三成路76号

电话：0574-88011699

传真：0574-87157176

邮箱：sales@alctron-audio.com

网址：<http://www.alctron-audio.com> 全国统一服务热线：4000-160-112