

Digital Piano  
**WK-300/310**  
Owner's Manual

**NUX**

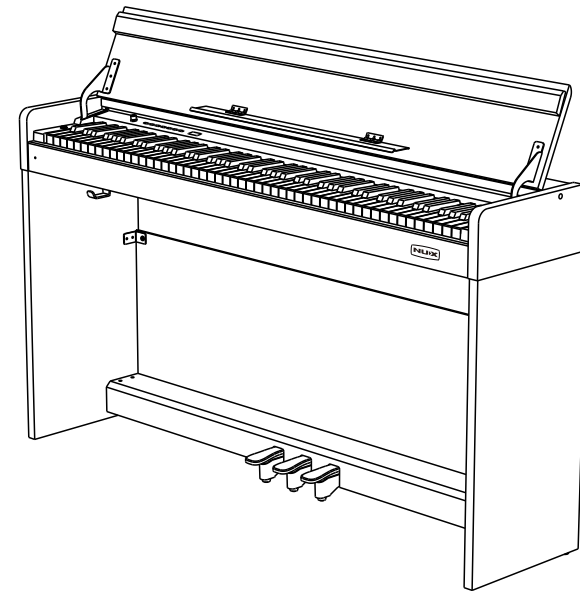

**Cherub Technology Co.,Ltd.**

Add: Room507, Block 1, Nanhai E-Cool, No. 6 Xinghua Road, Shekou, Nanshan District,  
Shenzhen City, Guangdong Province, China, 518067

Tel: +86 755 2686 9866 Fax: +86 755 2686 9366 E-mail: info@cherubtechnology.com



[www.nuxefx.com](http://www.nuxefx.com)

**Cherub Technology Co.,Ltd.**

Copyright 2018 Cherub Technology Co., Ltd. All rights reserved.

Strictly prohibit reproducing or spreading any part of this publication in any manner without the authorization of Cherub Technology Co., Ltd.

### **SAFETY GUIDELINE**

Before playing the digital piano, please read the following content.

Please put this instruction book in a safety place, in order to read it in the future.

### **WARNING**

In case of getting seriously injured or killed because of electric shock, short circuit, damage, fire or other dangers, please obey the following warnings. These warnings include but not limited to the following situations:

#### **Power/Electric Cable**

- \* The rated voltage of this device is fixed. The required voltage is printed on the nameplate of this device.
- \* Check the plug regularly, clean the dirt and ash piled up on the plug.
- \* This digital piano only matches with the provided power cable and plug.
- \* Please don't put electric cable beside heaters or radiators. Don't bend too much or cause damage to electric cable. Don't put any heavy stuff on the wire. Don't put it where it may be run over or trampled to make people stumble.

#### **Do Not Open**

- \* Please do not open this device and try to dismantle inner components or transform it in any ways. This device does not include any components for users to fix. If you find any problems, please stop using and ask qualified NUX service staffs to examine and repair the device.

### Warning about humidity

- \* In case of any liquid splashing into the device, please do not get this device rained or use it nearby water, in a wet surrounding or put a container of liquid on it. If any liquid, like water, splashes into the instrument, please cut off power and pull out the electric cable from the AC socket immediately. Then ask qualified NUX service staffs to examine and repair the device.
- \* Do not plug with wet hands.

### Fire

- \* Do not place any burning stuff, like candle, on the instrument. It may cause fire.
- \* When sensing any unusual situations, such as worn away and damage of power cable, sound suddenly stops during playing and the smell and smoke it causes, please turn off the power immediately and pull out plug from the socket. Ask qualified NUX service staffs to examine and repair the device.

### Attention

**In case that people around you and you get injured or get loss of device and property, please obey the following basic instructions. These instructions include but not limited to following situations.**

### Power/Electric Cable

- \* When pulling out plug from socket, please grab the plug instead of power cable. Drawing directly will cause damage to the power cable.
- \* If not using the instruments for a long time or during a lighting storm, please pull out plug from the socket.
- \* Do not connect the instrument to the socket by multiple connector, or it will lower the sound quality, or it will make socket overheat.

### Assemble & Use

- \* Please carefully read the attachment that explains the assemble process. If assembling the instrument in a wrong order, it will damage the instrument and hurt the user.
- \* Please connect the external equipment while the digital piano is off.

- \* Before using, please install the supporting screw and adjust it close to the ground, in case of trampling pedal.

### Mount Position

- \* In case of deformation of control panel and damage to inner components, please do not place this device in an environment with a lot of dirt, vibration, extreme cold and hot (such as, direct sunshine, closing to heater and inside a car under the burning sun)
- \* Please do not use this device near the television, radio, stereo, cell phone or other electronic devices. This may make noise on the device itself and television or radio nearby.
- \* Please do not put this device on unstable place, or it may cause a sudden fall down.
- \* Before moving the device, please pull out all electric cables from the socket.
- \* When you set this device, please confirm the AC socket going to be used is reachable. The device should be connected to the socket with protecting grounding connection. If you find any problems and questions, please immediately turn off the power and pull out the plug from the socket. Even though the power is turned off, there is still a small amount of electricity current flowing though it. If you decide not using this device for a long time, please pull out the plug from AC socket.
- \* This product uses all extreme power switch as a device to cut off from network power. The power switch button is on the right side of the keyboard. When the power button is pressed, it is switched on. When the power button up rises, it is switched off.

★ The graphic and screen in this hand book is only for introduction purpose. It may be different from the instrument you buy.

## Quick Installation Guide

### Assembly Components List

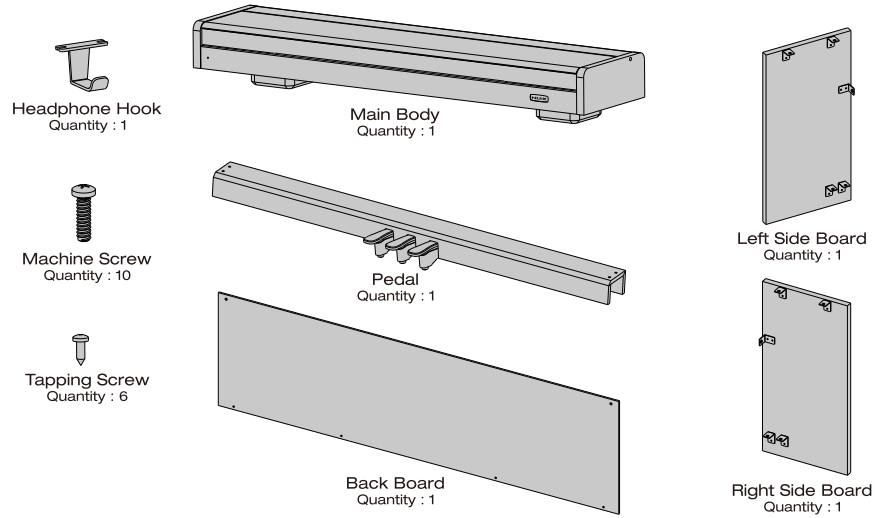

### Mounting Components

1. Mount left side board, right side board and pedal.

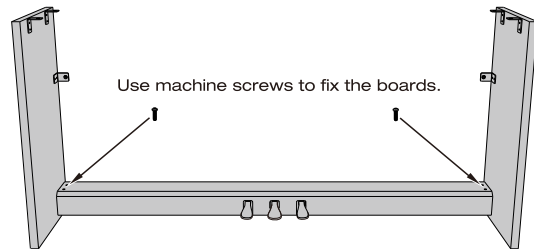

2. Mount back board.

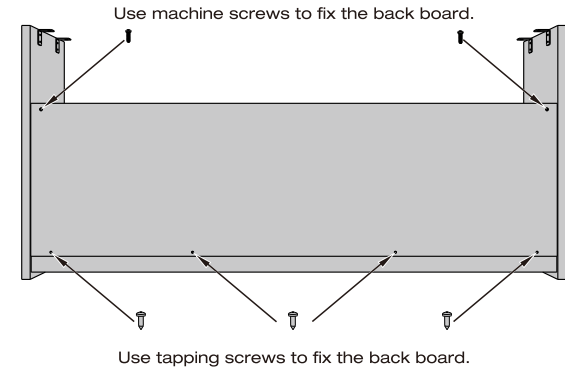

3. Mount headphone hook.

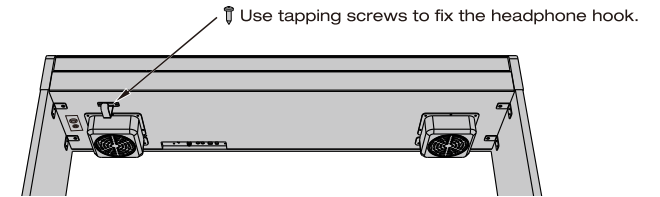

4. Mount main body.

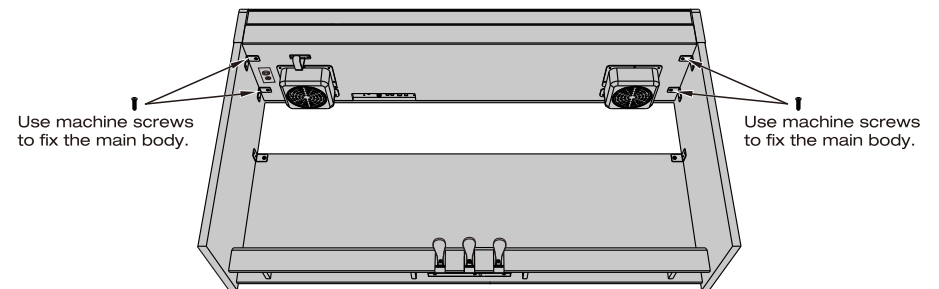

5. Installation complete.

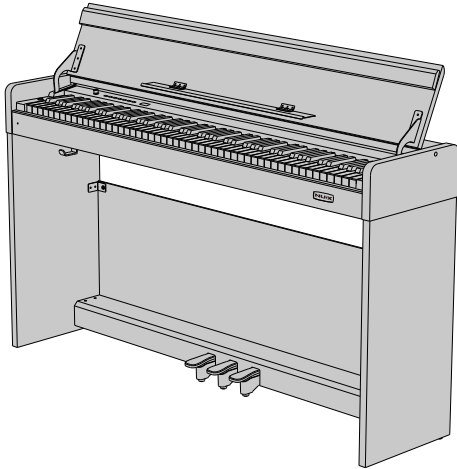

Thank you for choosing NUX Digital Piano. No matter you are a student, piano hobbyist or a professional player, this digital piano will impress you with its perfect sound and fashion design. It can be competent with piano studying, music listening, MIDI production, which satisfies your entertainment demand. It also has grand hammer dynamics keyboard, making you express yourself easily.

For further information about this new digital piano, we suggest you should read this hand book carefully in order to make full use of its advanced and convenient functions. Meanwhile, we also suggest you should keep this hand book well for reference in the future.

If you like NUX digital piano, please recommend NUX to your friends.

**Control Panel**

**Front Control Panel**

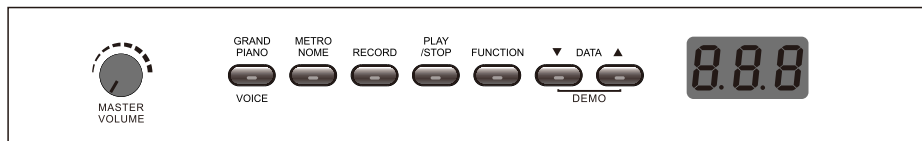

**Back Panel Interface**



**Power Supply**

Connect to a power adapter (DC 12V, 2000mA,  $\ominus \oplus$ )

**USB MIDI Jack**

Connect the computer to the USB MIDI Jack in the back panel to get MIDI Production Function.

**INPUT R/L Jacks**

Connect the external instrument/audio device to the built-in speaker system.

**OUTPUT R/L Jacks**

Connect the digital piano to a peripheral speaker system.

**Headphone Jack**

Standard stereo headphone jack(6.35mm). The built-in speaker system is invalid when this jack is connected.

**Pedal Jack**

Connect the pedal cable to this jack.

**Pedal**

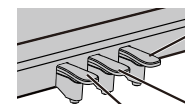

**Sustain Pedal (Right)**

When using the sustain pedal during the performance, the digital piano can keep a beautiful extended sound even though your hands leave the keyboard. The sustain effect is on when stepping down the pedal. The sustain effect is off when leaving the pedal. The sustain pedal also features a naturally expressive half-pedal.

**Damper Pedal (Middle)**

After pressing a key, step down the damper pedal in the middle can make a tenuto.

**Soft Pedal (Left)**

Decrease the volume by stepping down the left pedal.

**Before You Play**

**Power On**

Connect the plug to a proper socket and then press the [POWER] button on the left side of the keyboard to turn on the power. The default sound is grand piano.



**Volume Control**

Turn the [MASTER VOLUME] knob on the control panel to set the volume. Turn the knob clockwise to raise volume. Turn the knob anti-clockwise to reduce volume.

**Warning:** Too loud sound, especially when you wear the headphone, will do damage to hearing.



### Headphone Connection

Apart from the built-in speaker system, you can also connect a standard stereo headphone(6.35mm). Headphone jack is on the backboard of the piano. The built-in speaker system doesn't work after connecting the headphone. Adjust the headphone volume by turning the [MASTER VOLUME] knob.

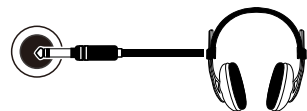

The built-in speaker system is invalid when the headphone is connected to this jack.

## Performance

### Sound Control

The default tone of WK-300 is grand piano (No.000). Use [DATA▼/▲] buttons to select tones. (The tone list is in the appendix).

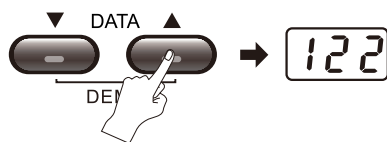

When you select other tone, press [VOICE] button and the digital piano will return to grand piano tone immediately.

### Function Control

As a user-friendly instrument, all functions in this digital piano can be activated easily. Every function is corresponding to a key.

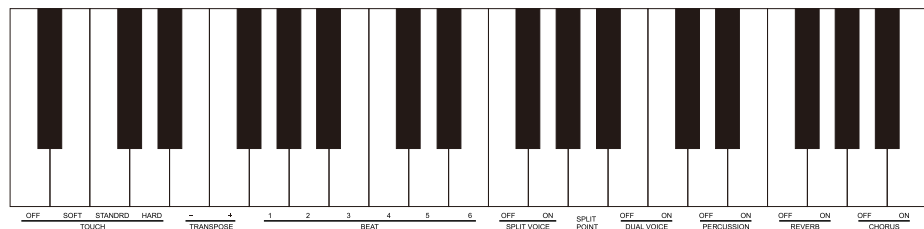

Function Activation: Press [FUNCTION] button, the indicator light turns on and function selection is activated. Press a key within 5 seconds to select corresponding function. Press [FUNCTION] button again or wait

for 5 seconds without any operation, the indicator light will turn off and exit function setting status. Now you can play the digital piano according to the chosen function mode.

**NOTE:** Under the status of function setting, key pressing is soundless.

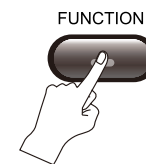

### Dynamic Curve

This digital piano has 4 dynamic curves, which are soft, standard, hard, dynamic on/off. Press [FUNCTION] button and the indicator light turns on. Press corresponding dynamic key within 5 seconds to activate dynamic function. The default dynamic curve is standard.

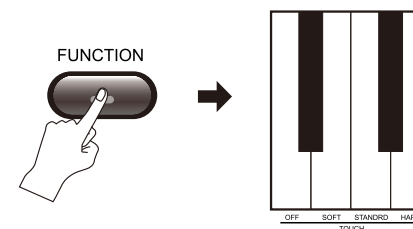

### Transposition

This function can transpose a note to move up or down by 12 semitones within one octave range. Press [FUNCTION] button and indicator light turns on. Press [TRANS-POSITION+/-] key within 5 seconds to adjust pitch. Adjusting range: -12 to +12. Press [FUNCTION] button again or wait for 5 seconds without any operation, the indicator light will turn off and transposition select function turns off.

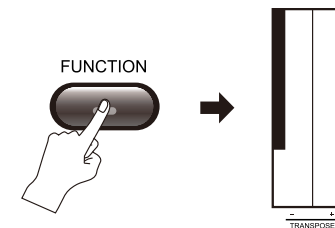

### Dual Keyboard

This function can divide the keyboard into two individual playing zones.

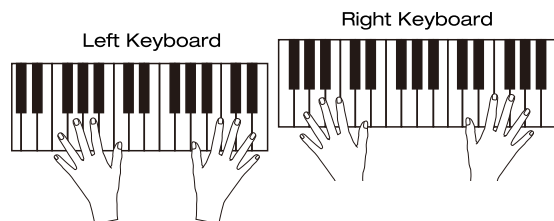

Before pressing [SPLIT] key, select sound for the left keyboard; Press [FUNCTION] button, the indicator light turns on, press [SPLIT] key within 5 seconds to enter split status. The keyboard is divided into two individual zones. The split point is F4. Select sound for the right side keyboard by [DATA ▼/▲] buttons.

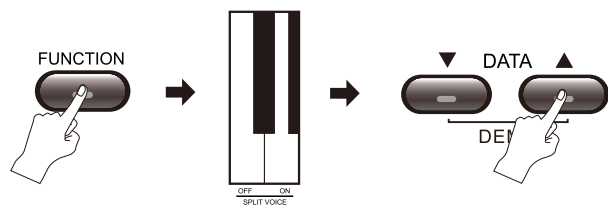

### Split Point

Press [FUNCTION] button and the indicator light turns on. Press [SPLIT POINT] button within 5 seconds to enter split point setting status. Now press any key to be the split point; Press [FUNCTION] button again or wait for 5 seconds without any operation until the indicator light turns off, the split point is set.

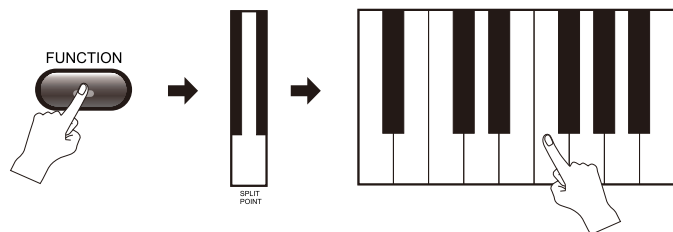

### Dual Voice

When this function is turned on, playing one note can have two voices. Press [FUNCTION] button, indicator light turns on. Press [DUAL VOICE] key within 5 seconds to enter dual voice status. Select 2nd sound by [DATA ▼/▲] button. 1st sound should be adjusted before entering dual voice status.

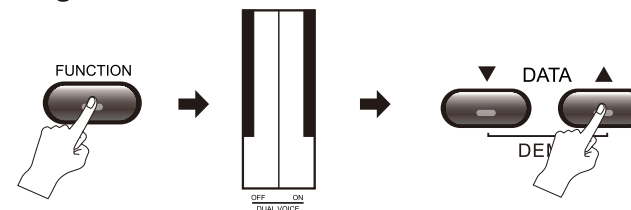

### Keyboard Percussion

Press [FUNCTION] button and the indicator light turns on. Press [PERCUSSION ON] key within 5 seconds to activate keyboard percussion. Press [FUNCTION] button and the indicator light turns on. Press [PERCUSSION OFF] key within 5 seconds to turn off keyboard percussion function. The digital piano will return to the original sound.

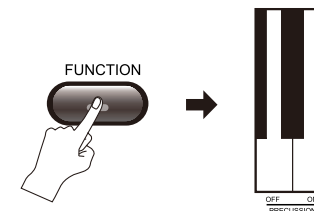

### Reverb

Press [FUNCTION] button and the indicator light turns on. Press [REVERB ON] key within 5 seconds to activate reverb function and sound will have reverb effect. Press [FUNCTION] button and the indicator light turns on. Press [REVERB OFF] key within 5 seconds to turn off reverb effect. (The default setting is off.)

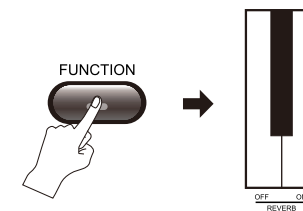



### Chorus

Press [FUNCTION] button and the indicator light turns on. Press [CHORUS] key within 5 seconds to activate chorus function and sound will have chorus effect. Press [FUNCTION] button and the indicator light turns on. Press [CHORUS OFF] key within 5 seconds to turn off chorus function.(The default setting is off.)

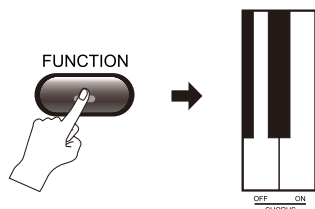

**NOTE:** All the settings will not be saved after power off. It will return to default setting when power on again.

## Practicing

### Metronome

- 1) Press[METRONOME]button. The indicator light turns on and the metronome function is activated. The default velocity is 120bpm.
- 2) Press [DATA▼/▲] button to set velocity: 20- 280bpm.
- 3) Press [METRONOME] button again to exit metronome function. The current setting will be saved.

**NOTE:** The velocity will be back to the default value after restarting the digital piano.

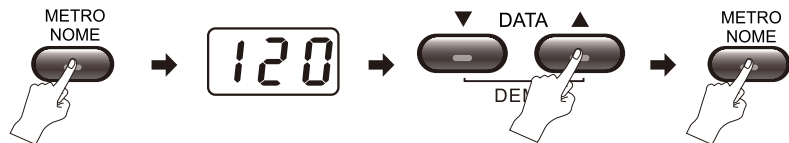

### Beat

This digital piano has six kinds of beats, which are 1,2,3, 4,5,6. Press [FUNCTION] button and the indicator light turns on. Press corresponding key within 5 seconds to set beat. Press [FUNCTION] button again or wait for 5 seconds without any operation, the indicator light turns off, the beat is set.

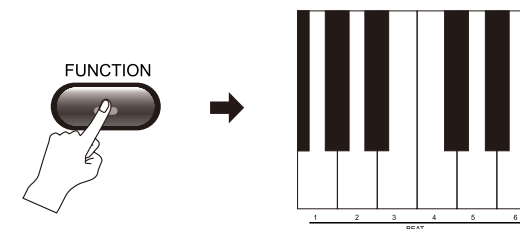

### Recording Function

#### 1) Start Recording

Press [RECORD] button to enter the recording standby status, the indicator light turns on. At the same time, the metronome turns on. If you do not need it, you can turn it off manually. Play any key and the recording will start automatically.



#### 2) End Recording

##### Automatic Stop:

During the recording process, when the storage space is full, recording will end automatically. The number of max. recording notes is 48000.

##### Manual Stop:

Press [RECORD] button again during the recording progress,the indicator light turns off and the recording stops.

**NOTE:** The recording content will not be saved after powering off.

##### Recording Playback:

When recording is over, press[PLAY/STOP] button to playback the recording. Press [PLAY/STOP] button again to stop playing.



### Demo Songs

**Play demo Songs:** There are 52 demo songs totally. Press [DATA▼/▲] two buttons together to start to play. Press [DATA ▼/▲] two buttons together again to stop playing.

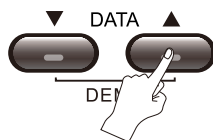

**Select Demo Song:** During the playing status, press [DATA▼/▲] button to select corresponding song.

### USB MIDI Function

Connect the computer to the USB MIDI Jack in the back panel to get MIDI Production Function.

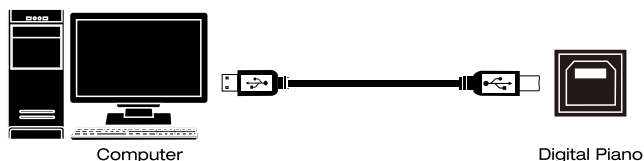

### Using the APP

WK-310 is compatible with the APP "Piano Mate" for iOS and Android. "Piano Mate" has a collection of onboard sheet music, and makes practicing and teaching more convenient. Scan the QR code and download the app corresponding to the mobile device you are using:



After installing the "Piano Mate" on your mobile device, you can register and open the sheet music. Then turn on the Bluetooth on the sheet music page, and select "NUX PIANO \*\*\*\*\*" for pairing connection.

**Note:** The Bluetooth connection between the digital piano and the "Piano Mate" APP does not require the Bluetooth Audio function. When the digital piano is powered on, the APP will automatically recognize it.

### Audio Connection

Audio Input:

Connect the musical instrument to the built-in speaker system, regarding the digital piano as speaker.

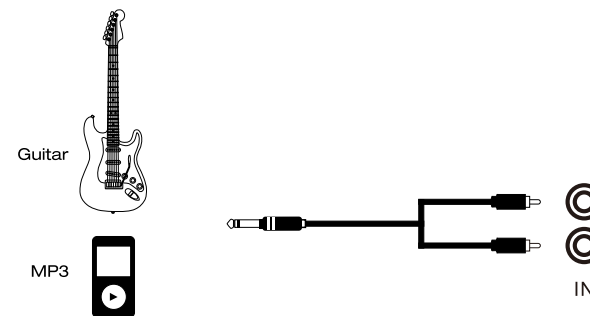

Output:

Connect the digital piano to the external speaker system, regarding it as sound source.

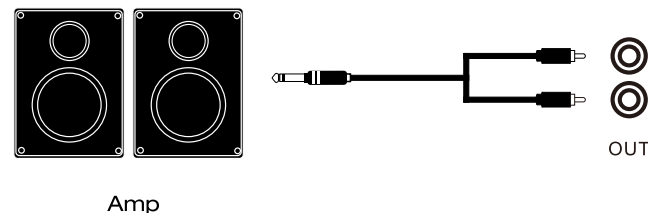

**Specification**

**Exterior:** Standard Upright

**Surface:** PVC

**Keyboard:** 88 keys scaled hammer action keyboard with four dynamic curves.

**Sound Source:** WK-300 using the French Dream 5704 DSP top audio source chip, WK-310 using the French Dream 5708 DSP top audio source chip; Germany Steinway grand piano sound and three-dimensional Sound sample, five - layer dynamic, string overtone resonance analog sound source technology

**Polyphony:** 180

**Bluetooth(WK-310):** To connect to App function

**Sound:** 128 tones + 1 standard percussion kits

**Demo Song:** 52 Demo Songs

**Dynamics:** 4 kinds of standard piano dynamics curves (soft, standard, hard, dynamic on/off)

**Metronome:** Velocity 20-280bpm, beat 1-6.

**Function Option:** Recording Function, Reverb, Chorus, Dual Voice, Dual Keyboard/Dual Piano

**Pedal Function:** Soft Pedal(left), Damper Pedal(Middle), Sustain Pedal(Right) The sustain pedal also features a naturally expressive half-pedal.

**Jack:** USB MIDI computer jack, pedal jack, power jack, stereo line input (x2)/ Output (x2), front dual headphone jack (6.35 / 3.5 jack)

**Power:** 10Wx2 DC12V 2000mA

**Dimensions:** 1360(L)x 320(W)x 770(H)mm

**Weight:** 39kg

**Accessories:** AC Adapter, Owner's Manual

★ Specifications may change without notice.

**Sound List**

Number	Instrument	Number	Instrument
<b>PIANO</b>		25	GTR STEEL
00	PIANO GRO	26	GTR JAZZ
01	PIANO BRITE	27	GTR CLEAN
02	PIANO ELEC	28	GTR MUTED
03	HONKY-TONK	29	GTR OVRDRV
04	E PIANO1	30	GTR DISTRT
05	E PIANO2	31	GTR HRMNX
06	HARPSCRD	<b>BASS</b>	
07	CLAVI	32	ACOU BASS
<b>GLOCK</b>		33	FINGR BASS
08	CELESTA	34	PICK BASS
09	GLOCKNSPL	35	FRETLS BASS
10	MUSIC BOX	36	SLAP BAS 1
11	VIBRAPHONE	37	SLAP BAS 2
12	MARIMBA	38	SYN BASS 1
13	XYLOPHONE	39	SYN BASS 2
14	TUBULR BELLS	<b>STRING</b>	
15	DULCIMER	40	VIOLIN
<b>ORGAN</b>		41	VIOLA
16	HAMND ORG	42	CELLO
17	PERC ORG	43	CONTRABASS
18	ROCK ORG	44	STR TREM
19	CHURCH ORG	45	STR PIZZ
20	REED ORG	46	HARP
21	ACCORDN 1	47	TIMPANI
22	HARMONICA	<b>CONCERT</b>	
23	ACCORDN 2	48	STRINGS 1
<b>GUITAR</b>		49	STRINGS 2
24	GTR NYLON	50	STR SYN 1

Number	Instrument	Number	Instrument
51	STR SYN 2	78	WHISTLE
52	CHOIR AAHS	79	OCARINA
53	VOICE OOHS	<b>SYNTH PIPE</b>	
54	VOICE SYN	80	SQR WAVE
55	ORCH HIT	81	SAW TOOTH
<b>BRASS</b>		82	CALLIOPE
56	TRUMPT	83	CHIFF
57	TROMBONE	84	CHARANG
58	TUBA	85	VOICE LEAD
59	MUTE TPT	86	5THLEAD
60	FR HORN	87	BASS LEAD
61	BRASS SECT	<b>SYNTH VOICE</b>	
62	BRASS SYN 1	88	NEW AGE
63	BRASS SYN 2	89	WARM PAD
<b>PIPE</b>		90	POLY SYNTH
64	SAX SOPRANO	91	CHOIR PAD
65	SAX ALTO	92	BOW GLASS
66	SAX TENOR	93	METAL PAD
67	SAX BTONE	94	HALO PAD
68	OBOE	95	SWEEP
69	ENG HORN	<b>SYNTH EFFECT</b>	
70	BASSON	96	RAIN FX
71	CLARINET	97	SNDTRK FX
<b>WOODPIPE</b>		98	CRYSTAL FX
72	PICCOLO	99	ATMOSPH FX
73	FLUTE	100	BRIGHT FX
74	RECORDER	101	GOBLIN FX
75	PAN FLUTE	102	ECHO FX
76	BOTTLE BLOWN	103	SCI-FI FX
77	SHAKHACHI		

Number	Instrument
<b>FOLK SOUND</b>	
104	SITAR
105	BANJO
106	SHAMISEN
107	KOTO
108	KALIMBA
109	BAGPIPE
110	FIDDLE
111	SHANAI
<b>PERCUSSION</b>	
112	TINKLE BELL
113	AGOGO
114	STEEL DRM
115	WOODBLK
116	TAIKO DRM
117	MLDY TOM
118	SYNTH DRM
119	REVR5 CYM
<b>EFFECT</b>	
120	GTR NOISE
121	BREATH
122	SEASHORE
123	BIRD TWEET
124	TELEPHONE
125	HELICOPTER
126	APPLAUSE
127	GUNSHOT

**Demo Songs List**

Number	NAME	Number	NAME
000	SYMPHONY OP.67 NO.5	026	AIR ON THE G-STRING
001	THE MAIDEN'S PRAYER	027	DANCE OF MIRLITONS
002	DREAM WEDDING	028	LONDON DERRY AIR
003	LA CAMPANELLA	029	IMPROMPTU
004	FOR ELISE	030	2-PARK INVENTION IN A MINOR
005	TURKISH MARCH	031	SPRING SONG
006	JOY TO THE WORLD	032	O SOLE MIO
007	GRANDFATER'S CLOCK	033	THE SIDEWAY
008	KATYUSHA	034	TENNESSEE WALTZ
009	SIPPIN'CIDER THROUGH A STRAW	035	WALTZ OF STARLIGHT
010	DANCE OF RUSSIA	036	OLD BLACK JOE
011	RED RIVER VALLEY	037	JAMBALAYA
012	SUSANNA	038	THE OLD GRAY MARE
013	AMERICAN PATROL	039	IN THE RAIN
014	IT'S BEGINNING TO LOOK A LOT LIKE CHRISTMAS	040	SILENT NIGHT
015	ENTERTAINMENT	041	FIVE HUNDRED MILES
016	IT'S A SMALL WORLD	042	SUMMER PALACE
017	SERENADE	043	LONG LONG AGO
018	FROHLICHER LANDMAN	044	LOVE IS ROMANTIC
019	NOCTURNE OP.9 NO.2	045	LAST ROSE OF SUMMER
020	PIZZICATO POLKA	046	MAPLE LEAF RAG
021	THE SONG OF ROSE	047	BLUE LUNCH
022	THE TROUT	048	COBWEB
023	NOCTURNE	049	REGGAE
024	SYMPHONE NO.94 SUPRISE	050	DARK EYES
025	HEIPENPOSLEIN	051	GIVE ME A ROSE

**Trouble Shooting**

Trouble	Possible Reason/Solution
The digital piano will puff when it is switched on.	Don't worry. This is normal.
Pressing key makes no sound after the power is on.	Please confirm whether the master volume button is set properly or confirm whether the headphone jack is linked to other devices, which will automatically cut off the built-in speaker system.
Notes have different quality under the same sound.	This is normal because different sound sampling ranges make different sound quality.
In pedal sustain function, some sound sustains longer, others shorter.	This is normal. The tenuto of different sounds of this digital piano has been set to optimized length.
The sound is too small.	Please confirm whether the master volume button is set properly.
Some MIDI Data can not be transmitted correctly (Even the MIDI cable is linked correctly).	This is normal. It is related to the original setting.
The speaker will make noise when cell phone is nearby.	The cell phone will jam when it is nearby. The cell phone should be turned off or keep the cell phone away from the digital piano to avoid the jam.
The pitch doesn't match with key actual place while playing.	Maybe the double keyboard function or transposition function is turned on. Turn off double keyboard or reset transposition to zero can solve the problem.

## Owner's Manual

<b>Trouble</b>	<b>Possible Reason/Solution</b>
The sound can not be changed while playing. The pitch doesn't match with key actual place.	Maybe the double keyboard function is turned on and the split point is set to the highest pitch. Turn off double keyboard function and set split point to original status can solve the problem.
The demo song distorts or interrupts.	Maybe it has been playing in maximum power for a long time so that the circuit board self-protection system is activated in case of overheat. Turn down the volume or turn off power for a while can solve the problem.
There are two sounds at the same time while playing.	Maybe you turn on dual voice function. Turn off dual voice function can solve the problem.
The tone's pitch is wrong.	Set scale and tones or set temperament parameter values to zero.
No automatic accompaniment chord.	Confirm whether accompaniment volume or chord function is turned on.
Dynamics is different from before.	This digital piano has four dynamics, light, standard, heavy, off. Maybe you have chosen different dynamics. You can choose the dynamics again according to your demand or reset it.

