

WWW.PASGAO.COM

PAW-260

Wireless Microphone Systems User Guide

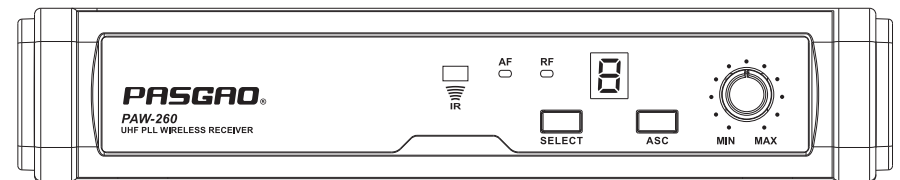

System Components

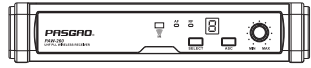

All systems include:

- PAW-260 receiver
- 2 "AA" batteries
- Power supply
- User guide

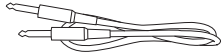

Vocalist system includes:

PAH-172 Handheld transmitter

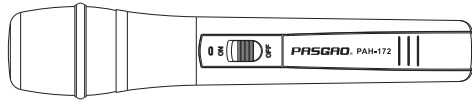
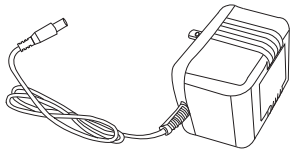

Lavalier/ Headworn system includes:

PBT-172 Bodypack transmitter
Microphone (choice of lavalier vocal or headworn vocal)

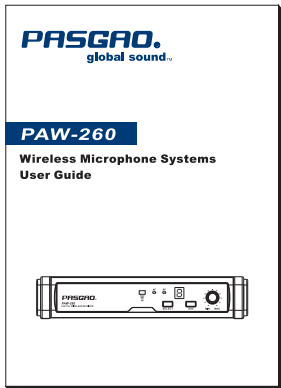
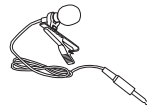

PAW-260 Receiver Features

Front Panel

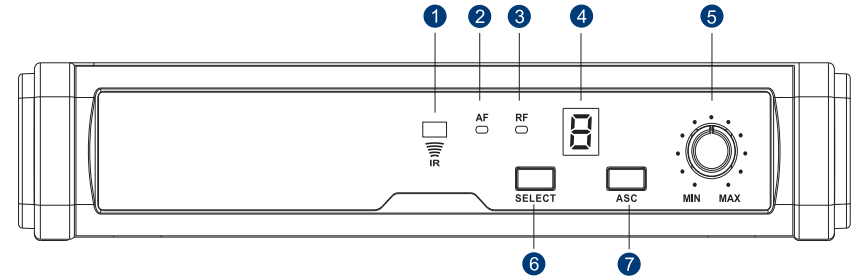

- Infrared (IR) window
- Audio signal indicator
- RF signal indicator light received by the transmitter signal
- LED display panel, see this page "System Settings"
- Audio output level control knob to the left to reduce the output level, rotate the right to increase the output level
- Channel regulation, see this page "System Settings"
- Sync Button
Press to initiate IR connection between receiver and transmitter.

Rear Panel

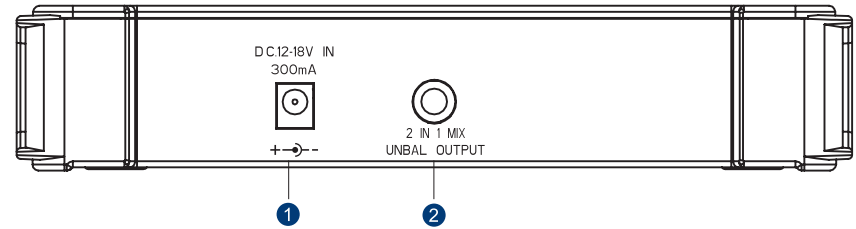

- DC power adapter socket
- 1/4 inch jack output mixed

System Setup

Receiver Programming



Channel Selection: Press "SELECT" button after the LED flashing, press to add a channel.

Note: When using multiple systems, it is best to set the maximum channel spacing for each system.

By "ASC" button, launching the infrared code signal, receiving the infrared signal to the frequency synchronization, the red light flashing: Infrared data transfer in progress.

Receiver volume control:
The audio output level control knob to the left to reduce the output level, rotate the right output level increases.

PAH-172 Handheld Transmitter

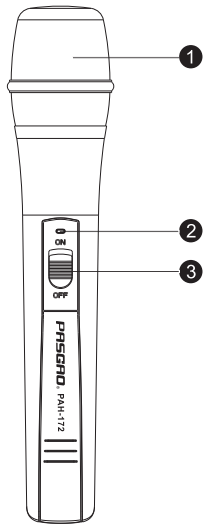

Features:

- ① Microphone head assembly
- ② Battery level indicator
red LED flashing when the battery low
green LED lighting when the power switch on
- ③ Power switch
- ④ Battery cover
- ⑤ IR Window
This window receives infrared signal so as to keep frequency synchronization.

Changing Batteries:

Expected life for two alkaline batteries is about 10 hours.
As the battery indicator on the screen keeps glowing, the batteries should be changed immediately (as shown below).

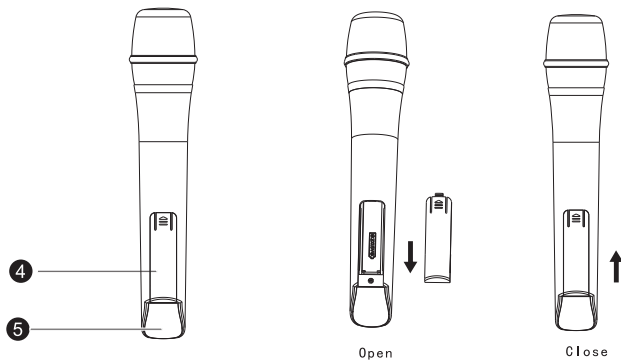

Handheld Transmitter Setup:

Switch off the handheld transmitter power, the rear infrared (IR) window aligned infrared receiver (IR) window, press the receiver "IR" button, then open the transmitter power switch.

Note: The receiver and transmitter in the establishment of an infrared connection between the two distances should be no more than 0.5 m; in the use of multiple systems, each time to establish an infrared connection can have only one window is aligned infrared transmitter receiver.

PBT-172 Bodypack Transmitter

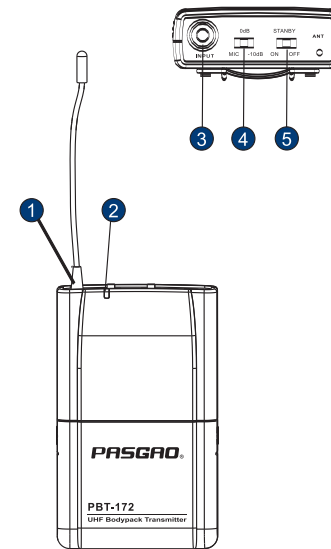

Features:

- ① Antenna
- ② Battery level indicator
red LED flashing when the battery low
green LED lighting when the power switch on
- ③ Microphone Input Jack
- ④ Gain adjustment switch and mute indicator
- ⑤ On/Off switch, when it in middle, keeping mute.
Two gain settings are available on,
choose the appropriate setting for your instrument
Mic: microphone
0: Guitar with passive pickups
-10dB: Guitar with active pickups
- ⑥ IR window
(receive IR signals to synchronize frequencies)

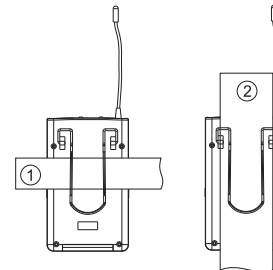

Wearing the Backpack Transmitter:

Clip the transmitter to belt ①, or slide a guitar strap through the transmitter clip ②, as shown.
For best results, slide the transmitter until the belt ① is pressed against the base for the clip.

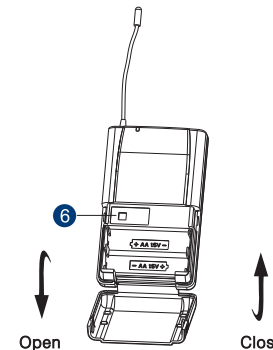

Changing batteries:

Expected life for Two Alkaline batteries is approximately 10 hours.
When the transmitter light glows red, the batteries should be changed immediately, as shown on the left.

Trips for improving System Performance

- Maintain a line of sight between transmitter and antenna.
- Avoid placing the receiver near metal surfaces or any digital equipment (CD players, computes, etc)
- Keep the receiver away from the wall and over 1m to the ground
- Cellular telephones and two-way radio and so on can interfering the transmitting frequencies, maintain a distance from the interfering equipments or any cause interfering.

Troubles Shooting

Issue	Indicator Status	Solution
No sound or faint sound	No Transmit	Turn on transmitter Make sure the +/- indicator on battery match the transmitter terminals
	No Receive	Make sure AC adapter is securely plugged into electrical outlet and into DC input connector on rear panel of receiver.
	Receiver RF indicator glows	Turn the receiver up Turn up the Gain adjustment switch in the transmitter Check the power connection of the receiver and amplifier or mixer
	Receiver RF indicator off, transmitter on	Take the receiver away from the metal objects Check whether there is hamper between receiver and transmitter Move the transmitter near the receiver Check the receiver and transmitter whether use the same frequency
	The battery power indicator light flashes	Change the batteries in transmitter
Distortion or unwanted noise bursts	Receiver display indicators antenna activity	Remove nearby sources of RF interference(CD players, computers , digital effects ,in-ear monitor systems, etc.)
Distortion level increases gradually	Transmitter power indicator light flashing on	Replace transmitter batteries
Sound level different from cabled guitar or microphone, or when using different guitars		Adjust transmitter again and receiver volume as necessary

Specifications

System

Frequency Range and Transmitter Output level

Band	Range	Transmitter RF level
UA	518-548 MHz	13dBm
UB	630-660 MHz	13dBm
UC	740-770 MHz	10dBm
UD	800-822 MHz	10dBm
UE	838-865 MHz	10dBm

Operating Range under Typical Condition

50m (150 ft.)

Note: actual range depends on RF signals absorption, reflection, and interference.

Audio Frequency Response (+/-3 dB)

60Hz~16KHz

Total Harmonic Distortion

(+/- 30 KHz deviation, 1 KHz tone)

<1%

Dynamic Range

>90 dB (A - weighted)

Operating Temperature Range

-10°C to +50°C

Note: battery characteristics may limit the range

Body pack Transmitter

Audio Input Level Maximum

0 dBV ~+20 dBV

Gain adjustment Range

20 dB

Input Impedance

470 kilohm

105mm H × 65mm W × 23mm D

Weight

80 grams without batteries

Power Requirement

Two “AA” size alkaline or rechargeable batteries

Battery life

> 10 hours (Alkaline)

Handheld Transmitter

Audio Input Level maximum

0 dBV

Dimensions (including the microphone)

245mm × 47mm Diameter

Weight

195 grams

Battery Requirements

2 “AA” alkaline batteries or rechargeable

batteries Battery Life

> 10 hours (Alkaline)

Receiver

Audio Output Level Maximum (ref. +/-30 KHz, 1 KHz)

XLR connector (into 600 Ω load): -12 dBV

1/4inch connector (into 3000 Ω load): -18 dBV

Output Impedance

1/4inch connector 1kilohm

Sensitivity (intermediate frequency adjustment

audio noise output <-90 dBm)

Image Rejection

> 60 dB

Dimensions

210mm × 116mm × 42mm

Power Requirements

12-18 Vdc at 300 mA , supplied by external power supply